

www.pulsehardware.com

uPVC Hardware



Sense . Style . Security

Espagnolette (Euro type)
Code : PL10213, PL10223, PL10233, PL10243, PL10263, PL10273

New



- Application : uPVC window
- Finish : Zinc plated
- Special Feature : Multipoint locking mechanism for casement windows with adjustable roller locking points
- : Available in different sizes

For enquiry call us now on +91-11-47348888, email: info@pulsehardware.com

We guarantee dispatch within 48 hours of order confirmation



Sense . Style . Security

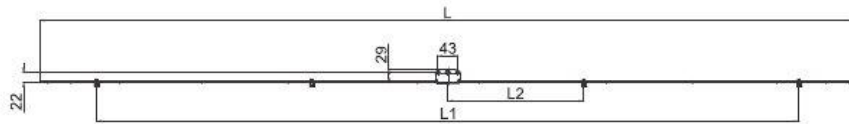

Code	L (mm)	L1 (mm)	L2 (mm)	Backset (mm)
PL10213	600	350	NA	22
PL10223	800	550	NA	22
PL10233	1000	868	94	22
PL10243	1200	1068	94	22
PL10263	1600	1350	94	22
PL10273	1800	1550	300	22

VER-2.1

Universal strikers

New



PL10902



PL10907



PL10906



PL10905



PL25801

We guarantee dispatch within 48 hours of order confirmation

For enquiry call us now on +91-11-47348888, email: info@pulsehardware.com



Sense . Style . Security

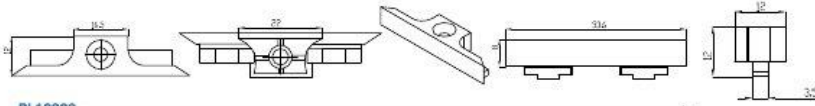

PL10902

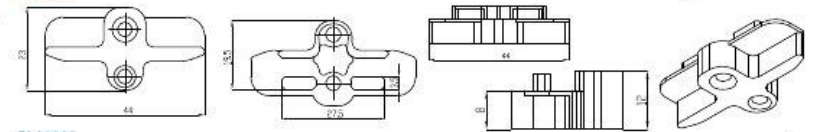

PL10906

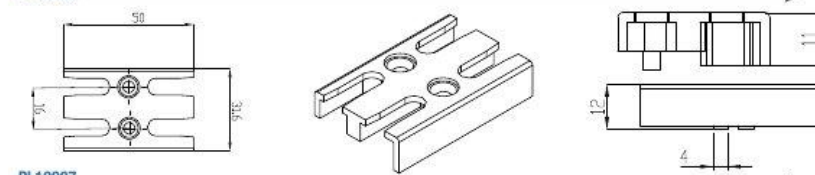

PL10907

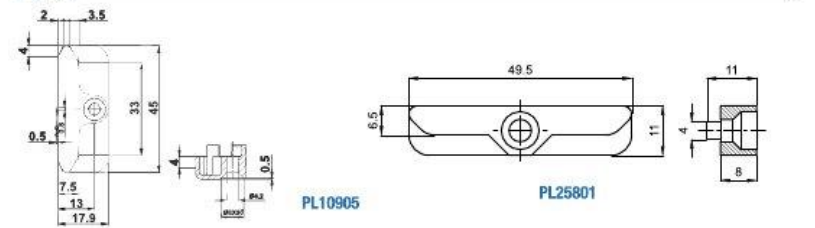

PL10905

PL25801





Tilt and turn kit for casement windows
Code: PL10604, PL10605, PL 10606, PL10614, PL10615, PL10616

New

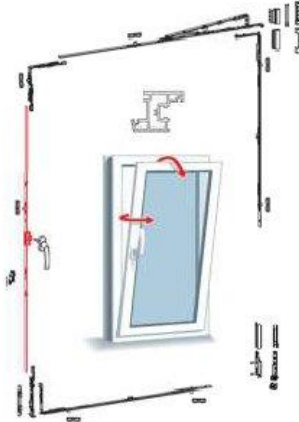

- Application** : uPVC sliding windows
- Finish** : Zinc plated
- Special Feature** : For tilt and turn side hung casement windows
- : Window with tilt and turn function made of high quality steel
- : Weight capacity 80 kgs

We guarantee dispatch within 48 hours of order confirmation

For enquiry call us now on +91-11-47348888, email: info@pulsehardware.com



Sense . Style . Security

Code	Width	Height	Backset
	(mm)	(mm)	(mm)
PL10604	601-800	1301-1400	15
PL10605	601-800	1401-1600	15
PL10606	601-800	1601-1800	15
PL10614	801-1000	1301-1400	15
PL10615	801-1000	1401-1600	15
PL10616	801-1000	1601-1800	15



Tilt and turn kit for casement windows
Code: PL10604, PL10605, PL 10606, PL10614, PL10615, PL10616



Espagnolette
Code : PL25273, PL25374, PL25384



We guarantee dispatch within 48 hours of order confirmation



Application : uPVC casement doors
Finish : Zinc plated
Special Feature : Multipoint locking mechanism for casement doors without key locking facility

For enquiry call us now on +91-11-47348888, email: info@pulsehardware.com



Sense. Style. Security.

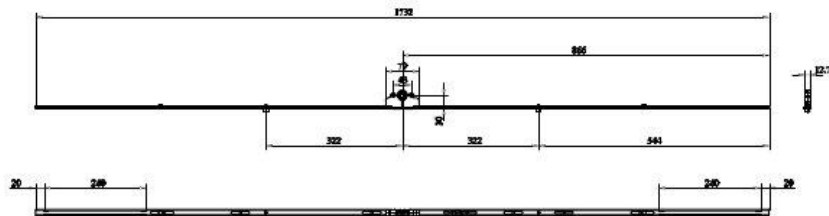

Code	Backset (mm)	Length (mm)	L (mm)	Spindle Dia. (mm)	Remark
PL25273	30	1800	644	7	Non Lockable
PL25374	35	1800	110	7	Non Lockable
PL25384	35	2000	110	7	Non Lockable





Espagnolette
Code : PL25274, PL25284, PL25301



Application : uPVC casement doors
Finish : Zinc plated
Special Feature : Multipoint locking mechanism for casement doors without key locking facility

For enquiry call us now on +91-11-47348888, email: info@pulsehardware.com

We guarantee dispatch within 48 hours of order confirmation



Sense . Style . Security

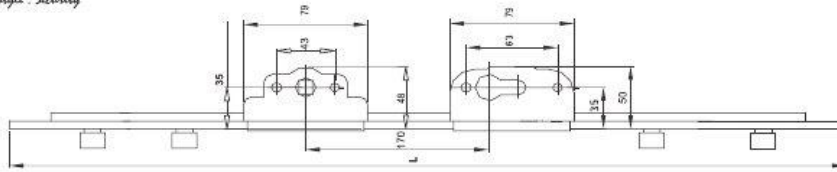

Code	Backset (mm)	Length (mm)	Lock width (mm)	Distance (mm)	Spindle Dia. (mm)	Remark
PL25274	35	1800	50	145	7	Lockable
PL25284	35	2000	50	145	7	Lockable
PL25301	35	2100	50	170	7	Lockable





uPVC Hardware



Sense . Style . Security



Espagnolette Handle
Code : PL50513

New

- Application** : uPVC sliding window
- Finish** : Powder coated white /black
- Special Feature** : Multi point locking espag handle for sliding window without key

We guarantee dispatch within 48 hours of order confirmation

For enquiry call us now on +91-11-47348888, email: info@pulsehardware.com



Sense . Style . Security

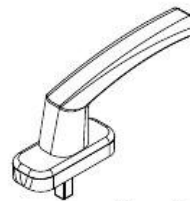
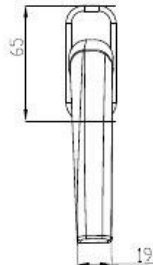
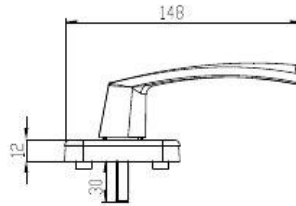
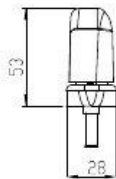

Espagnolette Handle
Code : PL50513



www.pulsehardware.com



uPVC Hardware

Espagnolette
Code : PL50831, PL50841, PL50851, PL50871, PL50881

New



- Application** : uPVC sliding windows
- Finish** : Galvanized steel
- Special Feature** : Multipoint locking mechanism for sliding windows
- : 2 or 3 locking points and anti lift mechanism for enhanced security
- : Rubber stopper for noiseless closing
- : 7.5mm backset

We guarantee dispatch within 48 hours of order confirmation

For enquiry call us now on +91-11-47348888, email: info@pulsehardware.com



Sense. Style. Security

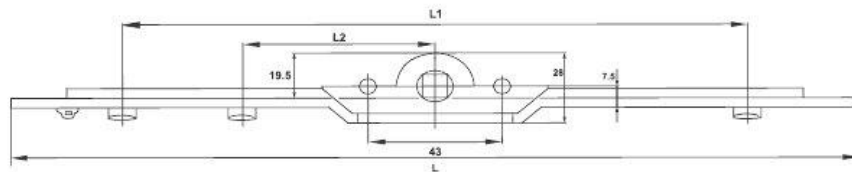

Code	Backset (mm)	L(mm)	L1(mm)	L2(mm)	Spindle DIA.(mm)	Remark
PL50831	7.5	800	560	NA	7	Non-Lockable
PL50841	7.5	1000	760	NA	7	Non-Lockable
PL50851	7.5	1200	960	170	7	Non-Lockable
PL50871	7.5	1600	1424	120	7	Non-Lockable
PL50881	7.5	1800	1560	170	7	Non-Lockable



VER-2.1

Striker (Silver)
Code : PL50925S

New



- Application : uPVC sliding windows
- Finish : Metallic
- Special Feature : It has anti-lift feature for extra security measure

For enquiry call us now on +91-11-47348888, email: info@pulsehardware.com

We guarantee dispatch within 48 hours of order confirmation



Sense . Style . Security

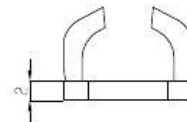
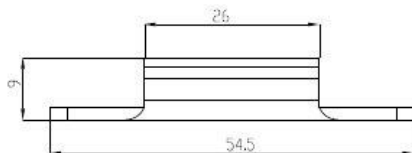
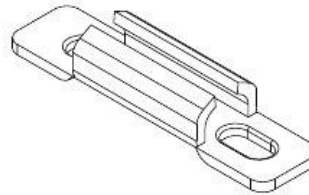
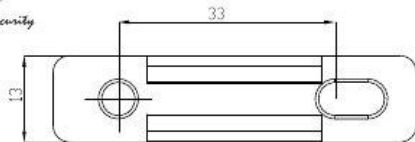

Striker (Silver)
Code : PL50925S



Single Roller With Groove
PL50573A



Single Roller With Groove
PL50574A



Double Roller With Groove
PL50671A



Single Roller With Groove
PL50575

- Application** : uPVC sliding window
Finish : Zinc / Stainless steel
Special Feature : Made to fit all euro groove and non euro groove profiles
 : Choices available for different sash weight
 : Made of high quality zinc alloy or plated steel body and nylon wheels
 : High quality needle/ ball bearing for noiseless operation and high load bearing capacity

For enquiry call us now on +91-11-47348888, email: info@pulsehardware.com



Sense . Style . Security

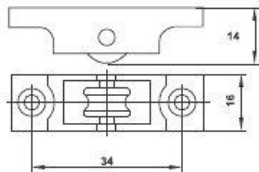

Single Roller With Groove
PL50573A

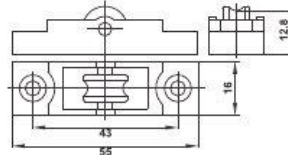

Single Roller With Groove
PL50574A

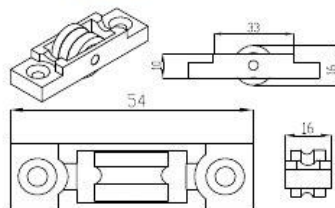

Single Roller With Groove
PL50575

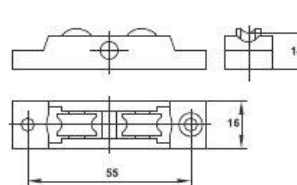

Double Roller With Groove
PL50671A



Code	Roller type	Width (mm)	Height (mm)	Weight (mm)
PL50573A	Single Roller with Groove	16	14	40
PL50574A	Single Roller with Groove	16	12.8	40
PL50575	Single Roller with Groove	16	16	40
PL50671A	Double Roller with Groove	16	14	60

www.pulsehardware.com

uPVC Hardware



Sense . Style . Security

Espag Packer
Code : PL502EP

New



Application : Sliding doors / windows
Finish : Black nylon
Special Feature : Espag spacer

We guarantee dispatch within 48 hours of order confirmation

For enquiry call us now on +91-11-47348888, email: info@pulsehardware.com



Sense . Style . Security

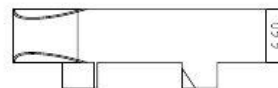
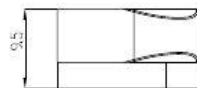
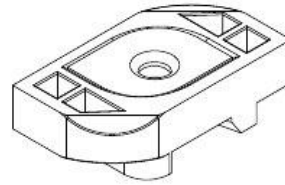
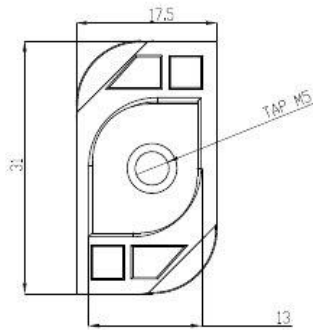

Espag Packer
Code : PL502EP

VER-2



Espagnolette
Code : PL75451, PL75461, PL75471A

New



- Application** : uPVC sliding doors
- Finish** : Zinc plated
- Special Feature** : Multipoint locking mechanism for sliding doors
- : 3 locking points and anti lift mechanism for enhanced security
- : Rubber stopper for noiseless closing
- : 15mm backset

We guarantee dispatch within 48 hours of order confirmation

For enquiry call us now on +91-11-47348888, email: info@pulsehardware.com



Sense . Style . Security

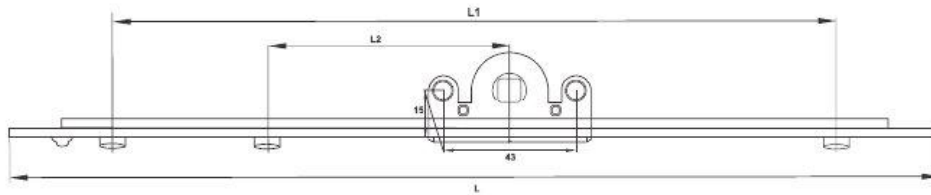

Code	Backset (mm)	L(mm)	L1(mm)	L2(mm)	Spindle Dia.(mm)	Remark
PL75451	15	1600	1428	122	7	Non-Lockable
PL75461	15	1800	1560	170	7	Non-Lockable
PL75471A	15	2000	1800	170	7	Non-Lockable



www.pulsehardware.com

uPVC Hardware



Sense . Style . Security

Bump Stopper
Code : PL75881

New



Application : uPVC sliding doors / windows
Finish : Nylon-Rubber
Special Feature : Protection against damage during fast open

We guarantee dispatch within 48 hours of order confirmation

For enquiry call us now on +91-11-47348888, email: info@pulsehardware.com



Sense . Style . Security

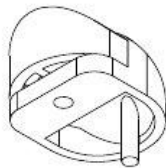
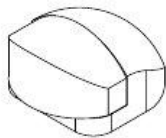
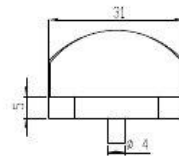
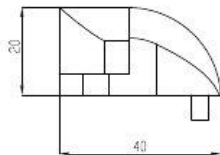

Bump Stopper
Code : PL75881

VER-2.1